

OPL25N



Low-level order picker 2500 kg maximum load capacity

DESCRIPTION

The OPL25N order picker combines unsurpassed operator comfort, maximum production, and excellent ergonomics. As a result, it is ideally suited for logistics warehouse operations.

The Schabmüller AC motor provides high power while the Zapi controller provides optimized and customizable configuration. In addition, its state-of-the-art electric power steering makes it extremely comfortable to operate.

Its intelligent slowdown function recognizes when the pallet truck is turning and intelligently reduces the truck's speed. It also switches on the daytime running light system for additional safety. Several fork lengths available, consult us.

A CONCENTRATE
OF POWER
AND INNOVATION



Available in option

- Lifting platform
- Lithium-ion battery



Innovative order picker



Ergonomic handle

Rema's ergonomic handle ensures a reliable control system. Each button is accessible and easy to use for superior comfort while driving.



USB port

The dual USB charging port can power up other devices.

The multi-functional control panel can display the equipment's operational status, operating time, battery status, driving speed, and steering angle.

The access control system allows setting multiple passwords to start the device by PIN code or by RFID card reader.

Smart design and easy maintenance



Various extension supports can be adapted, such as barcode scanners, device holders, storage trays, etc.



A large rubber protection bumper comes standard.



The order picker is equipped with forward/reverse and up/down buttons on both sides. As a result, the operator does not need to get on and off the platform to operate the truck. It improves picking efficiency and operational safety.



The upper fastening nut enables easy adjustment of the stabilizer wheel.





Lifting platform available in option

Lifting platform option

The lifting platform of the OPL25N is the ideal tool to increase productivity, comfort, and safety during storage and picking operations. The storage platform can reach up to 2850 mm thanks to the lifting platform, which elevates up to 850 mm high.

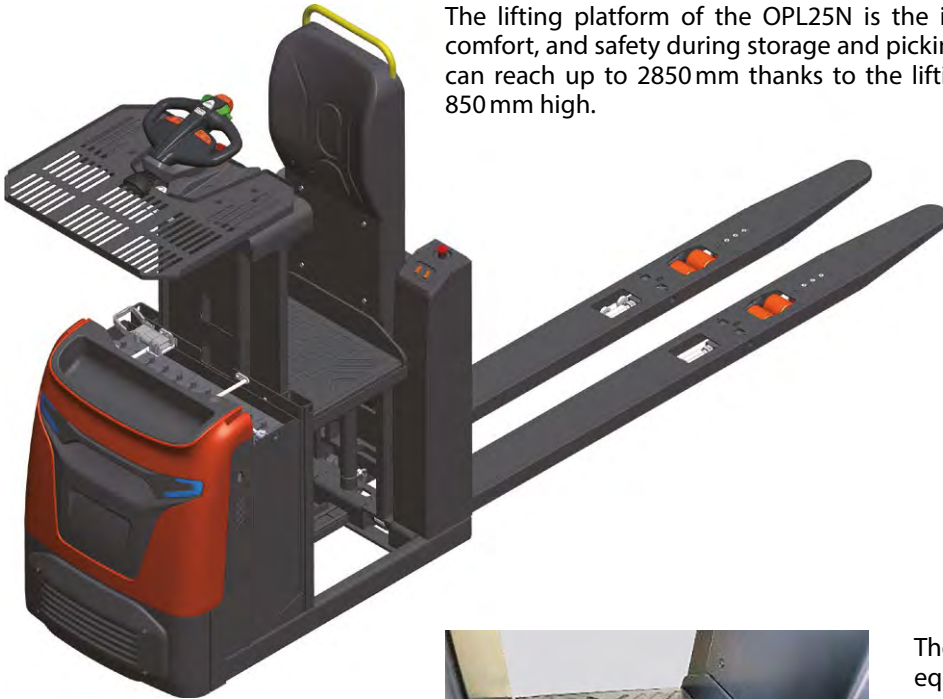

The lifting platform can also be equipped with a storage / picking tray.

"Hands-free" function is available in option. It enables the user to lower the platform with a simple double push on the foot pedal.





Safety flanks and non-slip surface materials on both sides of the backrest improve the operator's comfort and safety and reduce fatigue.









The automatic daytime running light system improves the safety of the operators significantly.



The order picker includes many storage spaces to optimize work.

HIGH-END COMPONENTS

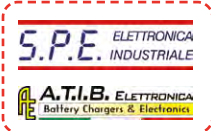
-  Multifunctional Rema handle with ergonomic contactless rocker-switches
(German)
-  AC Schabmüller traction motor
(German)
-  Kordel drive unit
(German)
-  Rader Vogel Steering wheels
(German)
-  Zapi electronic controllers
(Italian)
-  VIBO hydraulics
(Chinese)
-  SPE or ATIB chargers
(Italian)

High-end components reduce maintenance costs and guarantee high performance and reliability when performing the most intense operations.

Robust and durable construction, efficient and innovative driving technology



Powerful AC motor unit

The powerful, efficient and maintenance-free AC motor unit, designed and manufactured by Schabmüller, is paired with Kordel drive unit.



Zapi controller

Zapi, Italian electronic controllers offer a reliable and flexible high-performance solution.



Powerful and silent Vibo

It renders lifting operations easier and more efficient.

Kordel steering unit

Kordel's powerful and smooth steering unit increases the comfort of the user.

Photos and dimensions are not contractual. The manufacturer reserves the right to make any modification without notice, in order to improve the performance of the equipment.

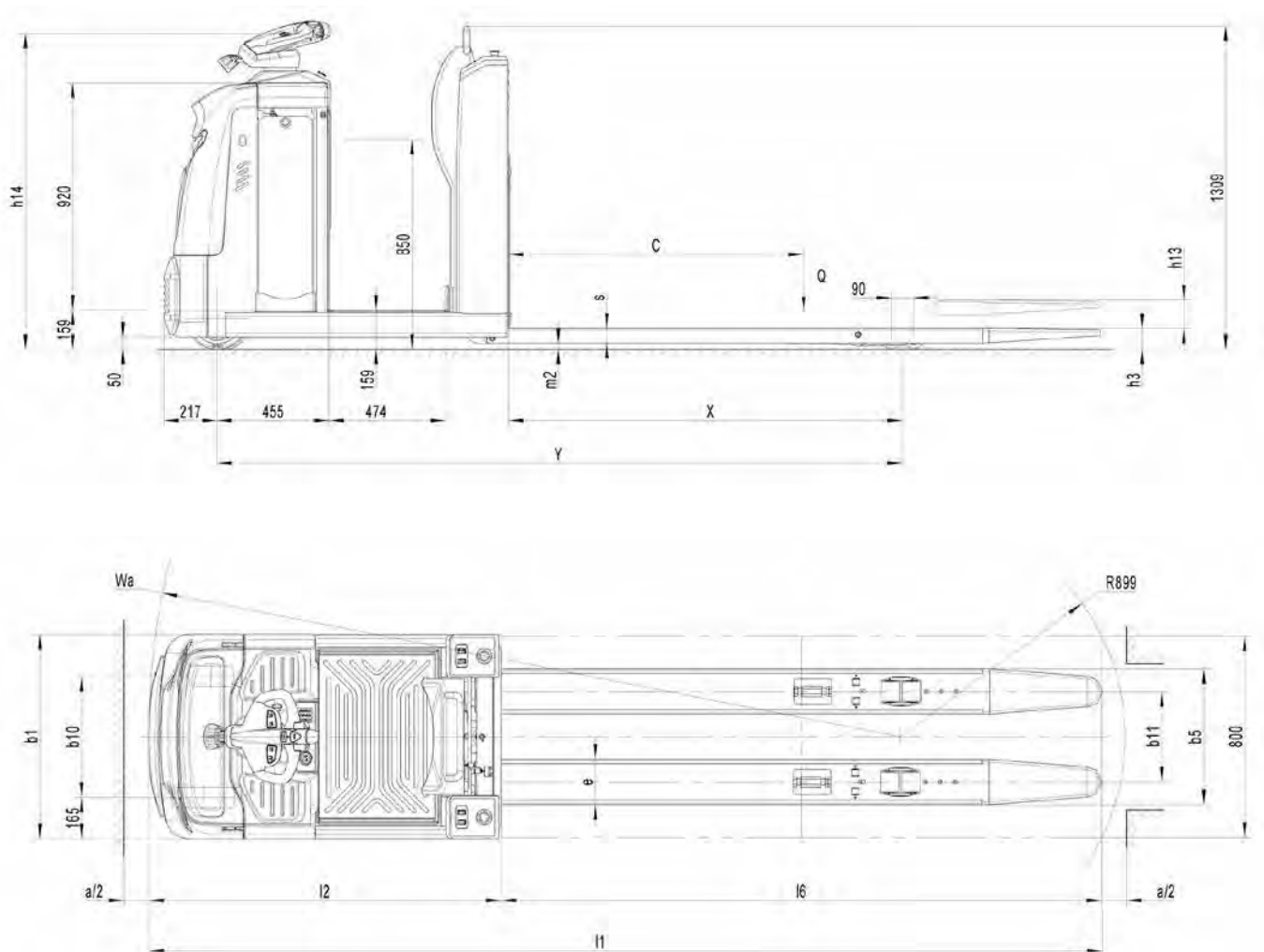

Technical data according to VDI 2198 regulation				
Specifications	1.2	Product Reference ♦ Model		OPL25N2400X540
	1.3	Power supply		battery
	1.4	Operator type		order picker
	1.5	Load capacity	Q(t)	2,5
	1.6	Load center distance	c(mm)	1200
	1.8	Distance from carriage to caster axle	x(mm)	1535 ⁽¹⁾
	1.9	Wheelbase	y(mm)	2723 ⁽¹⁾
Weight	2.1	Weight (batteries included)	kg	968
	2.2	Axle load laden front/rear	kg	1290/2530
	2.3	Axle load unladen front/rear	kg	980/340
Wheels	3.1	Wheels		polyurethane (PU)
	3.2	Steering wheel dimensions	Øxw(mm)	Ø250x80
	3.3	Load rollers dimensions	Øxw(mm)	Ø82x82
	3.4	Stabilizing rollers dimensions	Øxw(mm)	Ø180x80
	3.5	Number of front/rear wheels (x = driving wheel)		1+1x/4
	3.6	Front axle wheelbase	b10(mm)	480
	3.7	Load roller wheelbase	b11(mm)	360
Dimensions	4.4	Standard lift	h3(mm)	115
	4.9	Tiller height in drive position min/max	h14(mm)	1280
	4.15	Fork lowered height	h13(mm)	85
	4.19	Overall length	l1(mm)	3770 ⁽²⁾
	4.20	Front axle to fork face length	l2(mm)	2965 ⁽²⁾
	4.21	Overall width	b1(mm)	810
	4.22	Fork dimensions	s/e/l(mm)	60/180/2400
	4.25	Width across forks	b5(mm)	540
	4.32	Ground clearance	m2(mm)	25
	4.34	Aisle width for 1000x1200 mm pallets crossways	Ast(mm)	3970 ⁽³⁾⁽⁴⁾
4.35	Turning radius	Wa(mm)	2965 ⁽³⁾	
Performances	5.1	Travel speed, laden/unladen	km/h	9/12
	5.2	Lift speed, laden/unladen	mm/s	40/64
	5.3	Lowering speed, laden/unladen	mm/s	60/40
	5.8	Gradeability laden/unladen	%	6/12
	5.10	Service brake		electromagnetic
Electric system	6.1	Drive motor rating S2 60 min	kW	2,6
	6.2	Lift motor rating at S3 15%	kW	2,2
	6.3	Battery acc. to DIN 43531 / 35 / 36 A, B, C, No		no, 3PzS
	6.4	Battery voltage, nominal capacity K5	V/Ah	24/465
	6.5	Battery weight	kg	352
	6.6	Energy consumption acc. to VDI cycle	kWh/h	0,7
Additional data	8.1	Type of drive control		AC speed control
	8.4	Noise level at driver's ear acc. to EN 12053	dB(A)	<70

⁽¹⁾ After lowering the forks x = 1600 mm and y = 2788 mm

⁽²⁾ Install shock absorbers l1 = 3810 mm and l2 = 1409 mm

⁽³⁾ Install shock absorbers Wa = 3005 mm and Ast = 4010 mm

⁽⁴⁾ According to the VDI diagonal algorithm Ast = original measurement + 94 mm